

2024

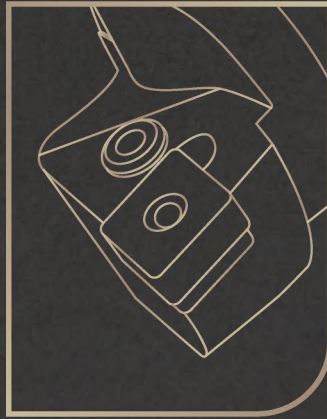

**减振杆**  
DAMPED TOOLS

## 公司简介

COMPANY  
PROFILE

- 百斯图工具隶属于厦门钨业股份有限公司，是一家专注于金属切削刀体的高新技术企业。集产品研发、工艺设计、生产制造、OEM/ODM代工、产品销售为一体的刀体制造企业。

SofTool is a member of Xiamen Tungsten Co., Ltd. It is a high-tech enterprise focusing on metal cutting tool bodies. As a steel product manufacturing enterprise integrating product research and development, process design, manufacturing, OEM/ODM, and product sales.

- 为全球客户专业提供PSC产品、铣刀体、钻杆、镗刀、液压刀柄、热装刀柄、夹具、曲轴、型线刀具等产品及个性化专属解决方案，产品应用覆盖了风（核）能发电、模具制造、汽车、工程机械、铁路、石油化工等各个领域。

We provide professional cutter tools and personalized and exclusive solutions for PSC product, milling tool bodies, drilling stem, boring tools, hydraulic chuck, shrink-fit chuck, chucks, crank shaft for global customers. Our products are applied in wind (nuclear) power generation, mold manufacturing, automobiles, construction machinery, railways, petrochemicals and other fields.



## 车削头命名方式 Cutting Head with Serrated Type Coupling Naming And Coding Rules

SR - S D U C R - 16 - 07 - F

01 - 02 03 04 05 06 - 07 - 08 - 09

## 减振杆命名方式 Damping Turning Bar with Serrated Type Coupling Naming And Coding Rules

SR - DT - 16 - 156 - CR - 40

01 - 02 - 03 - 04 - 05 - 06

### 01 接口形式 Serrated Type Coupling

SR

### 02 锁紧方式 Clamping

D	压板式 Platen
P	勾杆式 Hook
S	螺钉式 Screw

### 06 刀体方向 Direction of Tool

L	左手方向 Left
R	右手方向 Right
N	不区分左右手方向 Null

### 01 接口形式 Serrated Type Coupling

SR

### 02 减振 Damped Tool

DT

### 03 夹持柄径 Coupling Diameter

16

### 04 刀杆长度 Bar Length

156

### 05 材料 Work material

CR

### 06 刀头转接直径 Cutting Head Connection Diameter

40

### 备注:

当 5 列为空白, 代表钢制杆, CR 为硬质合金

当 6 列为空白, 代表无转接尺寸, 有数字代表转接直径

### 04 主偏角 Kr

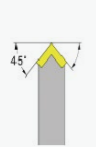
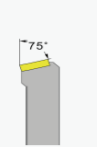
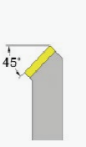
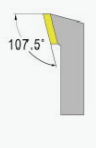
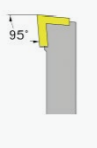
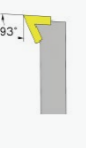
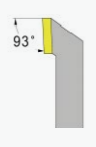
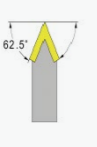
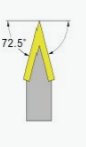
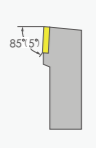
D		K		S	
H		L		U	
J		N		V	
X					

### 03 刀片形状 Shape

CC	DC	RC	VB
CN	DC	RC	VN
CN	DN	SN	WN
CN	DN	SN	WN
			TN

### 05 刀片后角 Angle

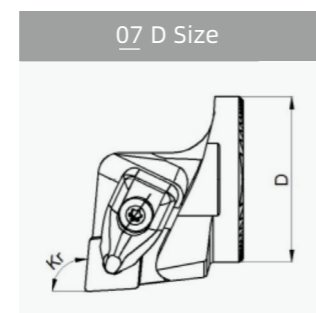

### 08 刀片 Insert

DC07  
DC11  
CN12

### 09 反镗 Back Boring

F

## 圆柄车削减振杆 CY-SRDT Series

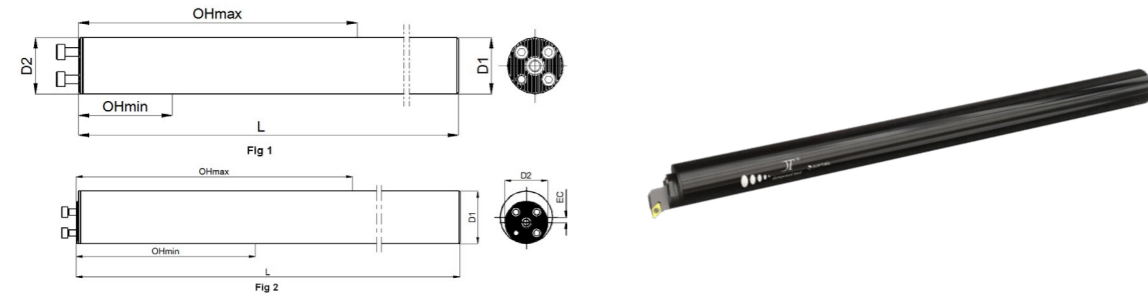

### > 技术参数 | Technical parameters

单位 | Unit: mm

订货号 Ordering Code	Fig	D1	D2	OHmin	OHmax	L	EC	ST	KG
SRDT-16-156	1	16	16	55	92	156	0	G1/8-28	0.2
SRDT-20-200	1	20	20	70	120	200	0	G1/4-19	0.4
SRDT-25-255	1	25	25	88	158	255	0	G1/4-19	0.9
SRDT-25-330	1	25	25	155	230	330	0	G1/4-19	1.2
SRDT-32-320	1	32	32	100	192	320	0	G3/8-19	1.9
SRDT-32-416	1	32	32	192	288	416	0	G3/8-19	2.6
SRDT-40-408	1	40	40	128	248	408	0	G1/2-14	3.5
SRDT-40-528	1	40	40	248	368	528	0	G1/2-14	5.1
SRDT-50-518-40	2	50	40	168	318	518	5	G1/2-14	7.3
SRDT-50-668-40	2	50	40	318	468	668	5	G1/2-14	9.3
SRDT-60-628-40	2	60	40	208	388	628	10	G3/4-14	12.7
SRDT-60-808-40	2	60	40	388	568	808	10	G3/4-14	16.5

### > 备件 | Accessory

D2	锁紧螺钉 Screw	锁紧螺钉扳手 Key(Screw)
16	113.030.10	241.025.56
20	113.035.10	241.030.63
25	113.040.12	241.030.63
32	113.050.12	241.040.70
40	113.060.12	241.050.80

- 订货包含配件，不供应刀片产品
- 可单独订购配件，按需询价

- The insert need to be ordered seperately. Other accessories are included in the order
- The sapare parts can be ordered seperately. Please inquire on demand

## 圆柄车削硬质合金减振杆 CY-SRDT-CR Series

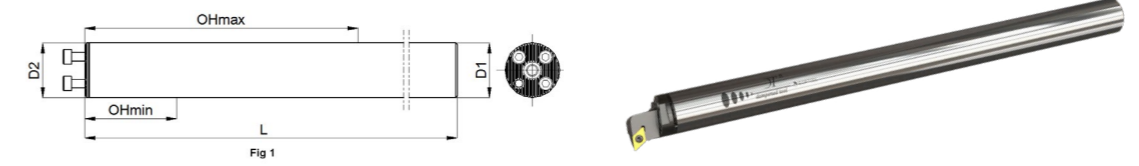

### > 技术参数 | Technical parameters

单位 | Unit: mm

订货号 Ordering Code	Fig	D1	D2	OHmin	OHmax	L	KG
SRDT-16-204-CR	1	16	16	96	140	204	0.4
SRDT-20-260-CR	1	20	20	120	180	260	0.8

### > 备件 | Accessary

D2	锁紧螺钉 Screw	锁紧螺钉扳手 Key(Screw)
16	113.030.10	241.025.56
20	113.035.10	241.030.63

- 订货包含配件，不供应刀片产品
- 可单独订购配件，按需询价

- The insert need to be ordered seperately. Other accessories are included in the order
- The sapare parts can be ordered seperately. Please inquire on demand

## 车削头 SR-CN -D 系列

SR-CN-D Series

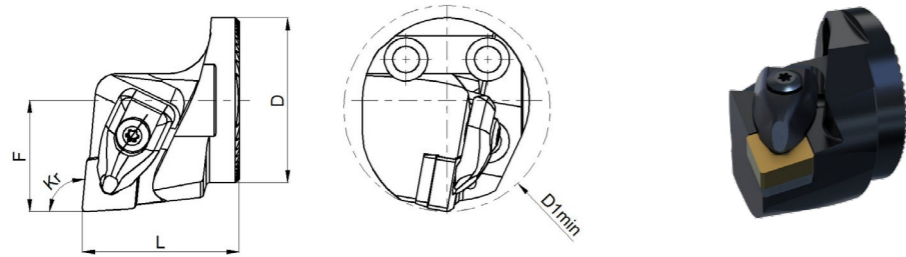

### > 技术参数 | Technical parameters

单位 | Unit: mm

订货号 Ordering Code	D	D1min	F	L	Kr	Kg	刀片 Insert
SR-DCLNR-32-12	32	40	22	38	95°	0.18	CN..120408
SR-DCLNL-32-12	32	40	22	38	95°	0.18	CN..120408
SR-DCLNR-40-12	40	50	27	38	95°	0.23	CN..120408
SR-DCLNL-40-12	40	50	27	38	95°	0.23	CN..120408

### > 备件 | Accessory

产品型号 Product ID	刀垫螺钉 Shim Screw	刀垫 Shim	扳手 Key	整套配件 Complete Clamp Set	定位管 Positioning Tube
SR-DCLNR-32-12	SFS 4085	322.236.03	248.150.10	412.028.021	552.058.02
SR-DCLNL-32-12	SFS 4085	322.236.03	248.150.10	412.028.021	552.058.02
SR-DCLNR-40-12	SFS 4085	322.236.03	248.150.10	412.028.021	552.058.02
SR-DCLNL-40-12	SFS 4085	322.236.03	248.150.10	412.028.021	552.058.02

- 订货包含配件，不供应刀片产品
- 可单独订购配件，按需询价

- The insert need to be ordered separately. Other accessories are included in the order
- The sapare parts can be ordered separately. Please inquire on demand

## 车削头 SR-CN -P 系列

SR-CN-P Series

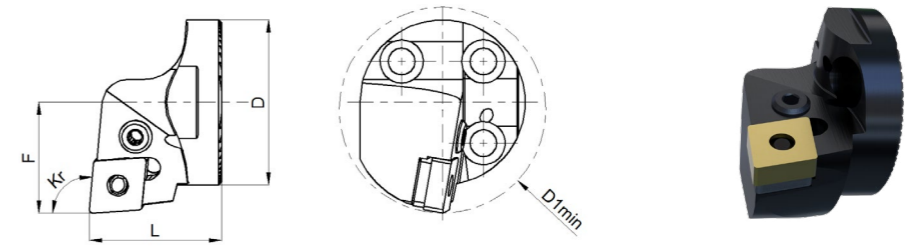

### > 技术参数 | Technical parameters

单位 | Unit: mm

订货号 Ordering Code	D	D1min	F	L	Kr	Kg	刀片 Insert
SR-PCLNR-32-12	32	40	22	32	95°	0.14	CN..120408
SR-PCLNL-32-12	32	40	22	32	95°	0.14	CN..120408
SR-PCLNR-40-12	40	50	27	32	95°	0.18	CN..120408
SR-PCLNL-40-12	40	50	27	32	95°	0.18	CN..120408

### > 备件 | Accessory

产品型号 Product ID	勾杆 Lever	螺钉 Screw	扳手 Key	刀垫 Shim	定位管 Positioning Tube
SR-PCLNR-32-12	413.438.48	414.438.58	241.030.63	322.318.50	552.058.02
SR-PCLNL-32-12	413.438.48	414.438.58	241.030.63	322.318.50	552.058.02
SR-PCLNR-40-12	413.438.41	414.438.21	241.030.63	322.318.50	552.058.02
SR-PCLNL-40-12	413.438.41	414.438.21	241.030.63	322.318.50	552.058.02

- 订货包含配件，不供应刀片产品
- 可单独订购配件，按需询价

- The insert need to be ordered separately. Other accessories are included in the order
- The sapare parts can be ordered separately. Please inquire on demand

## 车削头 SR-DC-S 系列

SR-DC-S Series

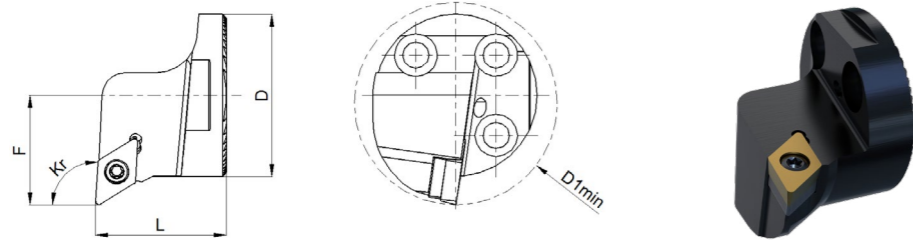

### > 技术参数 | Technical parameters

单位 | Unit: mm

订货号 Ordering Code	D	D1min	F	L	Kr	Kg	刀片 Insert
SR-SDUCR-16-07	16	20	11	20	93°	0.03	DC..070204
SR-SDUCL-16-07	16	20	11	20	93°	0.03	DC..070204
SR-SDUCR-20-11	20	25	13	20	93°	0.05	DC..11T308
SR-SDUCL-20-11	20	25	13	20	93°	0.05	DC..11T308
SR-SDUCR-25-11	25	32	17	20	93°	0.07	DC..11T308
SR-SDUCL-25-11	25	32	17	20	93°	0.07	DC..11T308
SR-SDUCR-32-11	32	40	22	32	93°	0.13	DC..11T308
SR-SDUCL-32-11	32	40	22	32	93°	0.13	DC..11T308
SR-SDUCR-40-11	40	50	27	32	93°	0.2	DC..11T308
SR-SDUCL-40-11	40	50	27	32	93°	0.2	DC..11T308

### > 备件 | Accessory

产品型号 Product ID	刀片螺钉 Insert Screw	刀片螺钉扳手 KEY(Insert)	刀垫 Shim	刀垫螺钉 Shim screw	刀垫螺钉扳手 KEY(Shim)	定位管 Positioning Tube
SR-SDUCR-16-07	SFS 2565	242.070.35	-	-	-	552.058.01
SR-SDUCL-16-07	SFS 2565	242.070.35	-	-	-	552.058.01
SR-SDUCR-20-11	SFS 3581	248.150.10	-	-	-	552.058.02
SR-SDUCL-20-11	SFS 3581	248.150.10	-	-	-	552.058.02
SR-SDUCR-25-11	ILD 3510	248.150.10	-	-	-	552.058.02
SR-SDUCL-25-11	ILD 3510	248.150.10	-	-	-	552.058.02
SR-SDUCR-32-11	SFS 3512	248.150.10	322.263.01	512.090.01	241.035.65	552.058.02
SR-SDUCL-32-11	SFS 3512	248.150.10	322.263.01	512.090.01	241.035.65	552.058.02
SR-SDUCR-40-11	SFS 3512	248.150.10	322.263.01	512.090.01	241.035.65	552.058.02
SR-SDUCL-40-11	SFS 3512	248.150.10	322.263.01	512.090.01	241.035.65	552.058.02

- 订货包含配件, 不供应刀片产品
- 可单独订购配件, 按需询价
- The insert need to be ordered seperately. Other accessories are included in the order
- The sapare parts can be ordered seperately. Please inquire on demand

## 车削头 SR-DC-S 系列

SR-DC-S Series

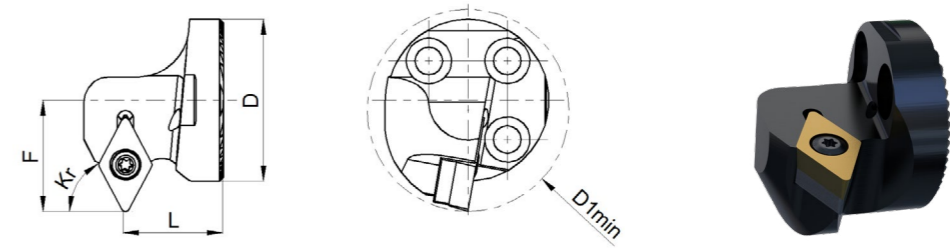

### > 技术参数 | Technical parameters

单位 | Unit: mm

订货号 Ordering Code	D	D1min	F	L	L1	Kr	Kg	刀片 Insert
SR-SDXCR-16-07	16	22	13	15	19.5	62.5°	0.03	DC..070204
SR-SDXCL-16-07	16	22	13	15	19.5	62.5°	0.03	DC..070204
SR-SDXCR-20-07	20	27	15	15	19.5	62.5°	0.04	DC..070204
SR-SDXCL-20-07	20	27	15	15	19.5	62.5°	0.04	DC..070204
SR-SDXCR-25-07	25	33	18	15	19.5	62.5°	0.06	DC..070204
SR-SDXCL-25-07	25	33	18	15	19.5	62.5°	0.06	DC..070204
SR-SDXCR-32-11	32	40	22	20	28	62.5°	0.12	DC..11T308
SR-SDXCL-32-11	32	40	22	20	28	62.5°	0.12	DC..11T308
SR-SDXCR-40-11	40	50	27	20	28	62.5°	0.18	DC..11T308
SR-SDXCL-40-11	40	50	27	20	28	62.5°	0.18	DC..11T308

### > 备件 | Accessory

产品型号 Product ID	刀片螺钉 Insert Screw	刀片螺钉扳手 KEY(Insert)	刀垫 Shim	刀垫螺钉 Shim screw	刀垫螺钉扳手 KEY(Shim)	定位管 Positioning Tube
SR-SDXCR-16-07	SFS 2565	242.070.35	-	-	-	552.058.01
SR-SDXCL-16-07	SFS 2565	242.070.35	-	-	-	552.058.01
SR-SDXCR-20-07	SFS 2565	242.070.35	-	-	-	552.058.02
SR-SDXCL-20-07	SFS 2565	242.070.35	-	-	-	552.058.02
SR-SDXCR-25-07	SFS 2565	242.070.35	-	-	-	552.058.02
SR-SDXCL-25-07	SFS 2565	242.070.35	-	-	-	552.058.02
SR-SDXCR-32-11	SFS 3512	248.150.10	322.263.01	512.090.01	241.035.65	552.058.02
SR-SDXCL-32-11	SFS 3512	248.150.10	322.263.01	512.090.01	241.035.65	552.058.02
SR-SDXCR-40-11	SFS 3512	248.150.10	322.263.01	512.090.01	241.035.65	552.058.02
SR-SDXCL-40-11	SFS 3512	248.150.10	322.263.01	512.090.01	241.035.65	552.058.02

- 订货包含配件, 不供应刀片产品
- 可单独订购配件, 按需询价
- The insert need to be ordered seperately. Other accessories are included in the order
- The sapare parts can be ordered seperately. Please inquire on demand

## 车削头 SR-DC-S 系列

SR-DC-S Series

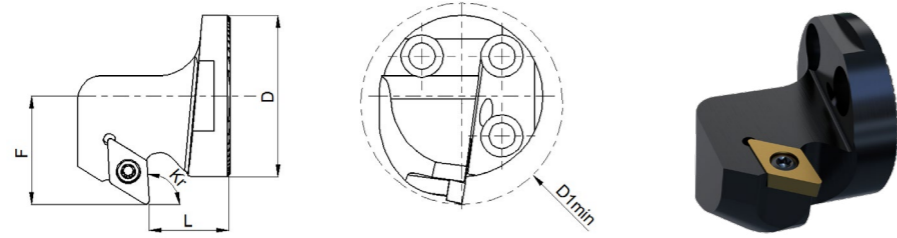

### > 技术参数 | Technical parameters

单位 | Unit: mm

订货号 Ordering Code	D	D1min	F	L	L1	Kr	Kg	刀片 Insert
SR-SDUCR-16-07-F	16	22	13	15	26.5	93°	0.03	DC..070204
SR-SDUCL-16-07-F	16	22	13	15	26.5	93°	0.03	DC..070204
SR-SDUCR-20-07-F	20	27	15	15	26.5	93°	0.05	DC..070204
SR-SDUCL-20-07-F	20	27	15	15	26.5	93°	0.05	DC..070204
SR-SDUCR-25-07-F	25	33	18	15	26.5	93°	0.06	DC..070204
SR-SDUCL-25-07-F	25	33	18	15	26.5	93°	0.06	DC..070204
SR-SDUCR-32-11-F	32	40	22	20	38	93°	0.14	DC..11T308
SR-SDUCL-32-11-F	32	40	22	20	38	93°	0.14	DC..11T308
SR-SDUCR-40-11-F	40	50	27	20	38	93°	0.22	DC..11T308
SR-SDUCL-40-11-F	40	50	27	20	38	93°	0.22	DC..11T308

### > 备件 | Accessary

产品型号 Product ID	刀片螺钉 Insert Screw	刀片螺钉扳手 KEY(Insert)	刀垫 Shim	刀垫螺钉 Shim screw	刀垫螺钉扳手 KEY(Shim)	定位管 Positioning Tube
SR-SDUCR-16-07-F	SFS 2565	242.070.35	-	-	-	552.058.01
SR-SDUCL-16-07-F	SFS 2565	242.070.35	-	-	-	552.058.01
SR-SDUCR-20-07-F	SFS 2565	242.070.35	-	-	-	552.058.02
SR-SDUCL-20-07-F	SFS 2565	242.070.35	-	-	-	552.058.02
SR-SDUCR-25-07-F	SFS 2565	242.070.35	-	-	-	552.058.02
SR-SDUCL-25-07-F	SFS 2565	242.070.35	-	-	-	552.058.02
SR-SDUCR-32-11-F	SFS 3512	248.150.10	322.263.01	512.090.01	241.035.65	552.058.02
SR-SDUCL-32-11-F	SFS 3512	248.150.10	322.263.01	512.090.01	241.035.65	552.058.02
SR-SDUCR-40-11-F	SFS 3512	248.150.10	322.263.01	512.090.01	241.035.65	552.058.02
SR-SDUCL-40-11-F	SFS 3512	248.150.10	322.263.01	512.090.01	241.035.65	552.058.02

- 订货包含配件，不供应刀片产品
- 可单独订购配件，按需询价

- The insert need to be ordered separately. Other accessories are included in the order
- The sapare parts can be ordered separately. Please inquire on demand

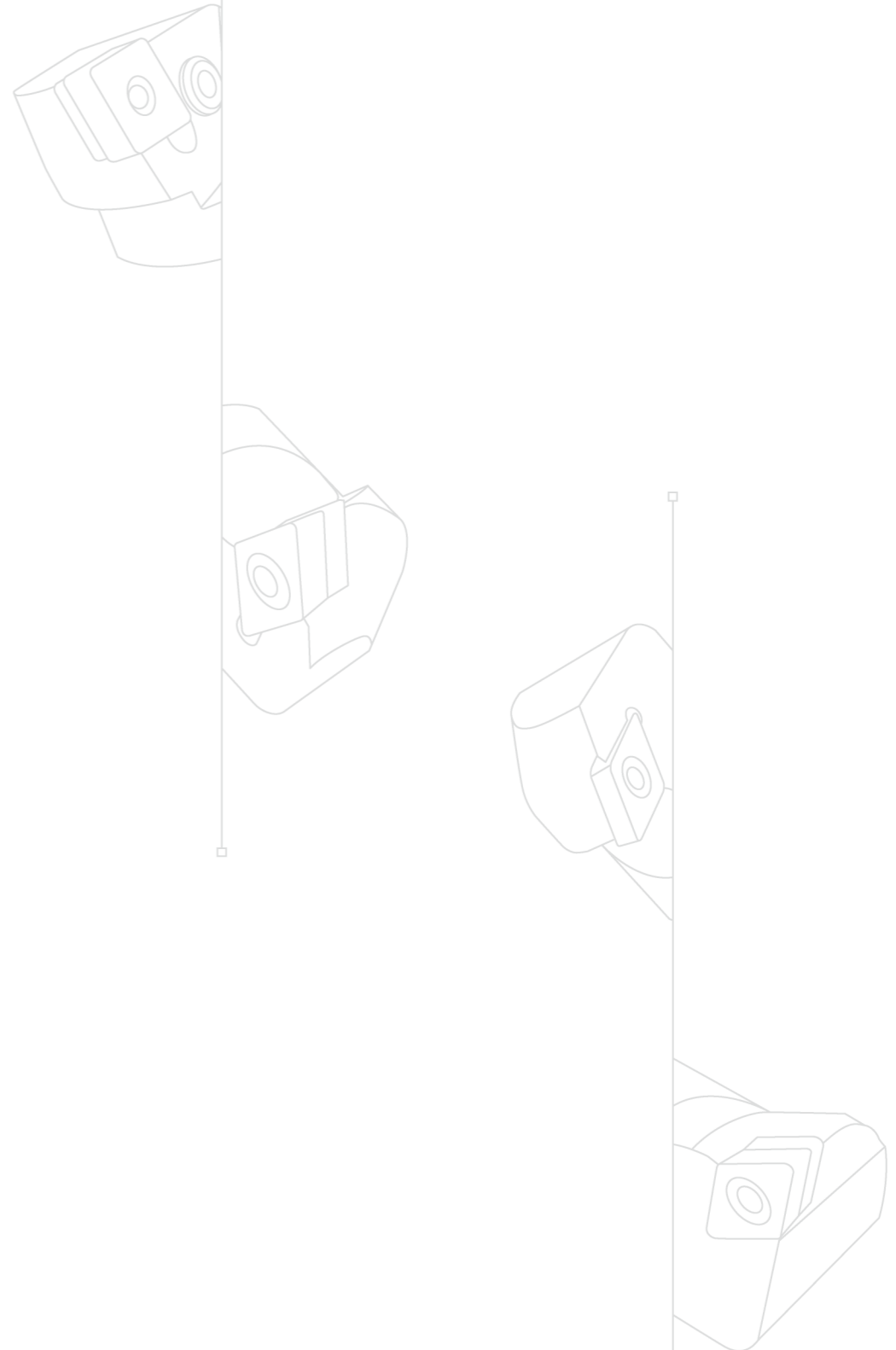

📍 全国区域	Nationwide	☎ +86 186 2267 5164
📍 华北区域	North China Area	☎ +86 177 3160 2890
📍 华中区域	Central China Area	☎ +86 189 0210 1516
📍 东北区域	Northeast Area	☎ +86 133 3205 6691
📍 西南区域	Southwest Area	☎ +86 185 0282 7181
📍 华南区域	South China Area	☎ +86 153 3200 8595
📍 西北区域	Northwest Area	☎ +86 133 3201 8652
📍 山东区域	Shandong Area	☎ +86 189 2021 6828
📍 华东一区 (上海、浙江)	East China Area I (Shanghai, Zhejiang)	☎ +86 189 0219 0578
📍 华东二区 (江苏、安徽)	East China Area II (Jiangsu, Anhui)	☎ +86 188 6213 2921
📍 OEM&海外	OEM&Oversea Sales	☎ +86 131 1000 1570
📍 外贸销售	Export Sales	☎ +86 189 2008 0858



— 微信公众号 —

ADD: 天津市武清区京滨工业园京滨大道99号

No. 99, Jingbin Avenue, Jingbin Industrial Park,  
Wuqing District, Tianjin, China

TEL: 022-60379917

E-mail: softool.sale@cxtc.com

WEB: www.xtc-softool.com