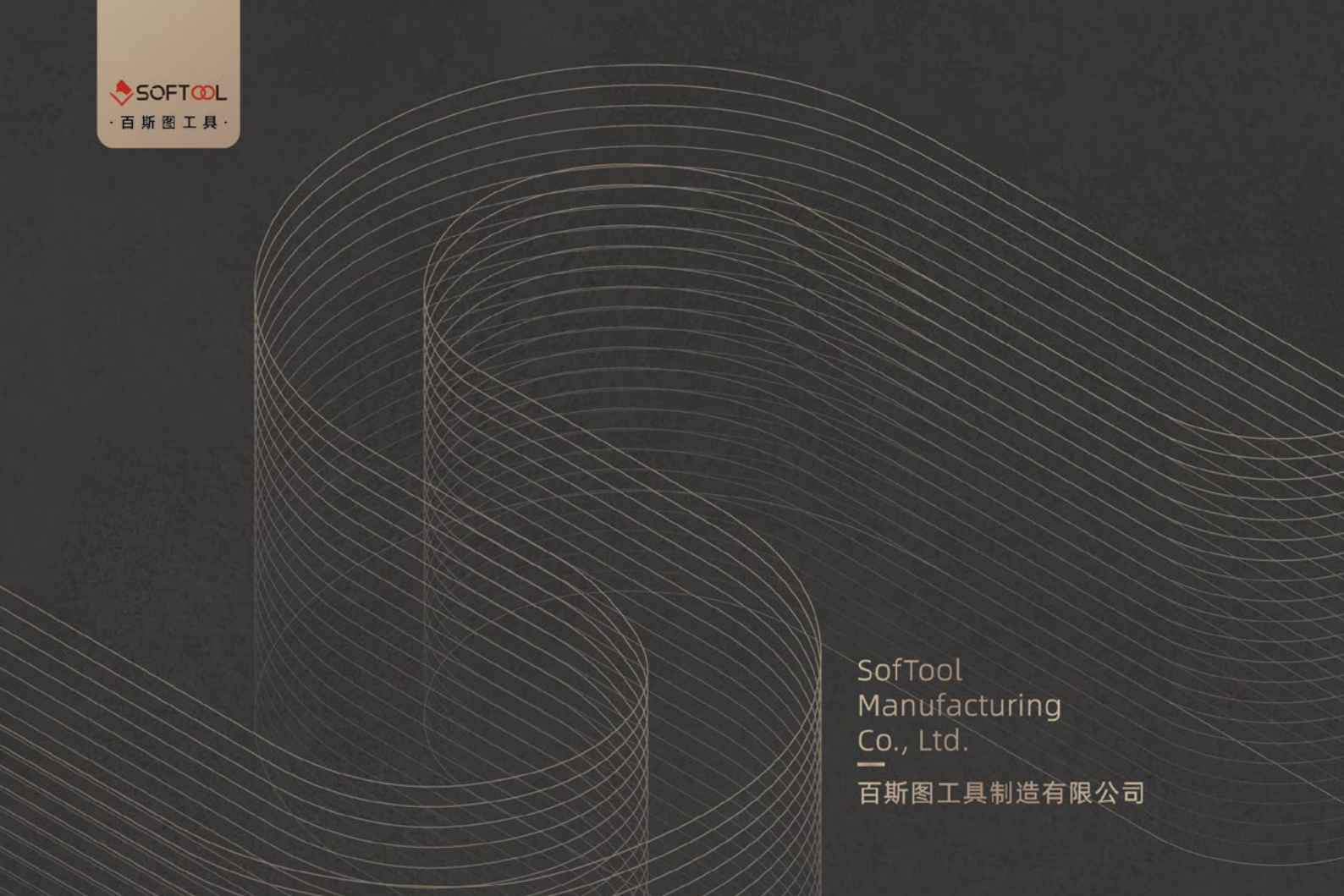
The logo for SofTool, featuring a red diamond shape with a white 'S' inside, followed by the word 'SOFTOOL' in white capital letters.

· 百斯图工具 ·

A large, abstract graphic composed of numerous thin, white, curved lines that create a sense of depth and movement, resembling a stylized 'S' or a series of overlapping waves. The lines are set against a dark, textured background.

SofTool
Manufacturing
Co., Ltd.

百斯图工具制造有限公司

是刀具
更是艺术

TOOLING
ALSO ARTS



- 百斯图工具隶属于厦门钨业股份有限公司，是一家专注于金属切削刀体的高新技术企业。集产品研发、工艺设计、生产制造、OEM/ODM 代工、产品销售为一体的刀体制造企业。

Softool is a member of Xiamen Tungsten Co., Ltd. It is a high-tech enterprise focusing on metal cutting tool bodies. As a steel product manufacturing enterprise integrating product research and development, process design, manufacturing, OEM/ODM, and product sales.

- 为全球客户专业提供 PSC 产品、铣刀体、钻杆、镗刀、液压刀柄、热装刀柄、曲轴、型线刀具等产品及个性化专属解决方案，产品应用覆盖了风（核）能发电、模具制造、汽车、工程机械、铁路、石油化工等各个领域。

We provide professional cutter tools and personalized and exclusive solutions for PSC product, milling tool bodies, drilling stem, boring tools, shrink-fit chuck, hydraulic chuck, crank shaft for global customers. Our products are applied in wind (nuclear) power generation, mold manufacturing, automobiles, construction machinery, railways, petrochemicals and other fields.



数读百斯图

HONOR AND PATENTS
OF SOFTOOL

10+ 行业奖项

Industry awards 10+

- 第二届切削刀具产品创新奖-金锋奖
- 荣格技术创新奖
- 2023 中国金属加工创新产品奖
-



100+ 新型专利

Utility model patents 100+

- 超强排屑快进给型腔铣刀
- 粗精一体圆柱销调节小直径镗刀
- 一种新型精镗连杆杆刀具
- 一种不使用刀夹的大直径深孔钻
- 一种新型易拆卸密封柱塞
- 一种新型小直径仿形铣铣刀
- 防震玉米铣刀
- 可换刀夹式刀盘
- 深孔扩孔钻
- 整体钻头
- 一种轴向可调节刀夹
- 一种高效切削镜面铣刀
-



多种业务模式

MULTIPLE BUSINESS
MODULESINDUSTRIAL
CUSTOMIZATION MODEL
行业定制模式

行业定制模式为客户解决曲轴、型线刀具加工等个性化专属解决方案

Industrial customization model provides customers with personalized and exclusive solutions for crankshaft and profile tool processing

NETWORK
CHANNEL MODEL
经销商模式

经销商模式为客户提供国际水准的刀具配套产品, 包括: PSC 产品、镗刀、刀柄等钢制品产品

The network channel model develops distributors to provide customers with international standardized cutting tool products, including PSC turning tool body, boring tools, hydraulic chuck, shrink chuck and other steel products

OEM/ODM MODE
OEM/ODM 模式

OEM/ODM 模式提供一站式服务, 解决铣、钻、车、镗、刀柄等产品研发 生产 质量 售后等问题, 为客户解决后顾之忧

The OEM/ODM model is to undertake all the processing business of steel products supporting tools, and provide one-stop services including product R&D, design, production and quality control. The strategic pattern of complementary resources can save the investment in machine tools and labor costs for tool companies



液压刀柄

HYDRAULIC
CHUCK



产品优势 PRODUCT ADVANTAGES

- 适用于钻削、铰削、镗削及铣削等切削加工
- 在 2.5xD 处回转精度 ≤ 0.003mm
- 转速为 25000rpm 时，平衡质量等级达到 G2.5 或 Umax < 1g·mm
- For drilling, reaming, boring, milling, and other cutting machining
- Runout ≤ 0.003mm at 2.5D
- Balancing Grade: G2.5 at 25,000 rpm or Umax < 1g·mm



SOFTOOL



应用行业 APPLICATIONS

- 应用于航空航天、模具制造、汽车制造、船舶制造、石油化工、电子制造等领域
- Can be widely used in the fields of aerospace, mold, automobile manufacturing, shipbuilding, petrochemical industry, Electronic manufacturing and so on



接口形式 | Coupling type

BT30-BT50
SK30-SK50
HSK32-HSK100
PSC40-PSC63

夹持直径 | Diameter
Φ6-Φ32

有效长度 | Length
50-200mm

通用型 (GP)



接口形式 | Coupling type

BT30-BT50
HSK63

夹持直径 | Diameter
Φ12-Φ32

有效长度 | Length
58-90mm

强力型 (HQ)



接口形式 | Coupling type

SK40、HSK63

夹持直径 | Diameter
Φ6-Φ20

有效长度 | Length
150/200mm

模具型 (DM)



接口形式 | Coupling type

SK50

夹持直径 | Diameter
Φ12, Φ20, Φ32

有效长度 | Length
110mm

磨刀机刀柄 (GM)



接口形式 | Coupling type

Φ12、Φ20、Φ16
Φ25、Φ32

夹持直径 | Diameter
Φ3-Φ25

减径套 (ISL)



接口形式 | Coupling type

BT40、HSK63、PSC63

夹持直径 | Diameter
Φ12, Φ20

有效长度 | Length
155/170mm

同步攻丝液压刀柄 (TAP)

热装刀柄

SHRINK-FIT
CHUCK



产品优势
PRODUCT
ADVANTAGES

- 热装刀柄自带螺纹平衡孔，可直接装配平衡螺钉进行动平衡调整
- 适用于钻削、铰削、镗削及铣削等切削加工
- 可提供环喷冷却定制
- 通用型基础上增加安全锁结构，适用于难加工材料切削
- The shrink-fit chuck has a thread balance hole, which can be directly assembled with a balance screw for dynamic balance adjustment
- For drilling, reaming, boring, milling, and other cutting machining
- Ring jet cooling can be customized
- Add safe lock structure on the basis of general purpose type, suitable for cutting difficult-to-machine materials

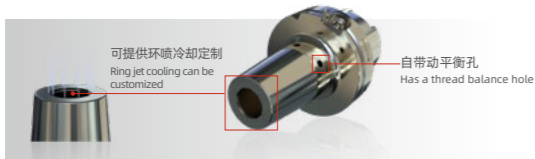

SOFTOOL



应用行业
APPLICATIONS

- 应用于航空航天、模具制造、汽车制造、船舶制造、石油化工、电子制造等领域
- Can be widely used in the fields of aerospace, mold, automobile manufacturing, shipbuilding, petrochemical industry, Electronic manufacturing and so on



接口形式 | Coupling type
BT30-BT50
SK30-SK50
HSK32-HSK100(A/E)

夹持直径 | Diameter
Φ3-Φ32mm

有效长度 | Length
60-200mm

通用型 (GP)



接口形式 | Coupling type
SK40、SK50、BT40、HSK63

夹持直径 | Diameter
Φ3-Φ32mm

有效长度 | Length
80-130mm

通用端冷型 (GC)



HAIMER 翰默
Safe-Lock 授权

接口形式 | Coupling type
SK40、BT40、HSK63

夹持直径 | Diameter
Φ6-Φ32mm

有效长度 | Length
80-120mm

安全锁型 (SC)



接口形式 | Coupling type
SK40、SK50
BT40、BT50
HSK63、HSK100
PSC63

夹持直径 | Diameter
Φ6-Φ32mm

有效长度 | Length
80-200mm

强力型 (HQ)



接口形式 | Coupling type
SK40A
HSK32E、HSK40E
HSK50E、HSK63A

夹持直径 | Diameter
Φ3-Φ16mm

有效长度 | Length
60-200mm

模具型 (DM)



接口形式 | Coupling type
SK40、SK50
BT30、BT40
HSK63

夹持直径 | Diameter
Φ3-Φ16mm

有效长度 | Length
75-200mm

强力模具型 (HD)

热装机

SHRINK-FIT



01

智能感应加热技术确保刀柄不过烧，延长刀柄使用寿命 20% 以上

Intelligent induction heating technology ensures that the knife handle does not over-heat, extending the knife handle's lifespan by over 20%

02

特殊设计的线圈加热更均匀和高效，可实现 5 秒换刀

Specially designed coil heating ensures more uniform and efficient heating, allowing for a knife change in 5 seconds

03

在连续工作状态下，机器不会产生过热，可实现批量化装卸刀作业

In continuous working conditions, the machine will not overheat, enabling batch loading and unloading of knives

热装机 冷却系统

COOLING SYSTEM



01

配合热装机使用，用于刀柄的冷却
Used with shrink-fit machine for cooling of the tool holders

03

快速冷却刀柄，刀柄不与冷却介质接触，延长刀柄寿命

Quick cooling for the holders without contacting with cooling medium, prolonging the holder's service life

02

针对本公司产品，冷却套匹配本公司出品刀柄的外形

For our products, the cooling sleeve matches the shape of the tool holders produced by SofTool

04

模具型热装刀柄需要配套模具型刀柄转换套使用

For the die & mold type of shrink chuck, it is necessary to match corresponding converter sleeves

镗刀

BORING
TOOLS

粗镗刀

ROUGH BORING
TOOLS



产品优势 PRODUCT ADVANTAGES

- 通过调整滑块可实现粗 - 半精镗一体化功能
- 高精度冷却液出水孔，使冷却液位置与刀尖随动，冷却液可直达刃口
- 航空铝桥架具有较轻的重量可减少主轴负载
- The integrated function of rough-semi-finish boring can be realized by adjusting the slider
- High-precision coolant outlet hole makes the coolant position follow up with the tool tip to ensure that the coolant can reach the cutting edge directly
- Aviation aluminum bridge with lessweight can reduce the spindle load



应用行业 APPLICATIONS

- 应用于航空航天、汽车、工程机械、石油、新能源、医疗、模具等领域
- Can be widely used in the fields of aerospace, automobile, construction machinery, petroleum, new energy, medical, mold and die and so on



冷却孔随动
Adjustable cooling hole

粗镗刀 BRA



直径范围 | Processing range
25mm-160mm

刀片类型 | Insert type
CC06-CC12、TC11-TC16、SC09-SC12

锁紧方式 | Clamping
螺钉式 Screw

接口规格 | Coupling type
CK、芯轴 Arbor

粗镗刀 BRB



直径范围 | Processing range
160mm-510mm

刀片类型 | Insert type
CC12、TC16-TC22、SC12
CN12-CN19、SN12-SN15

锁紧方式 | Clamping
压板式 Platen、螺钉式 Screw
勾杆式 Hook

接口规格 | Coupling type
芯轴 Arbor

转接柄 ADAPTOR



CK 基础柄系列 | CK

CK 转 PSC 系列 CK connection with PSC adaptor

CK 转 HSK 系列 CK connection with HSK adaptor

CK 转 BT 系列 CK connection with BT adaptor

CK 转 SK 系列 CK connection with SK adaptor

CK 转 CK 系列 CK connection with CK adaptor

芯轴基础柄系列 | Arbor

芯轴基础柄 BT 系列 Arbor Connection with BT adaptor

芯轴基础柄 HSK 系列 Arbor Connection with HSK adaptor

芯轴基础柄 SK 系列 Arbor Connection with SK adaptor

镗刀

BORING
TOOLS

精镗刀
FINE BORING
TOOLS



产品优势 PRODUCT ADVANTAGES

- 实现一刀多用，同一把精镗刀可实现正镗加工，背镗加工或套镗加工
- 内部高精度的螺纹配合，实现 0.002mm 的调整精度，数显镗刀实现 0.001mm 的调整精度
- 采用高压内冷孔设计，确保刀尖冷却精准性和有效性
- 垫圈方式调整扩展加工直径，节约刀具成本
- Fine boring tool can achieve positive boring, reverse boring and set boring
- Internal high-precision thread coordination achieves adjustment accuracy of 0.002mm, and digital display boring tools achieve adjustment accuracy of 0.001mm
- Adopting a high-pressure internal cooling hole design ensures precision and effectiveness in tool tip cooling
- Adjusting the processing diameter by the washer can save costs



应用行业 APPLICATIONS

- 应用于航空航天、汽车制造、重工业等领域
- Can be widely used in the fields of aerospace, automobile and heavy industry and so on



精镗刀 BFA



直径范围 | Processing range
20mm-160mm

刀片类型 | Insert type
TC06-TC11、TC1102
TB06、TP08、TP09

锁紧方式 | Clamping
螺钉式 Screw

接口规格 | Coupling type
CK

精镗刀 BFB



直径范围 | Processing range
160mm-525mm

刀片类型 | Insert type
TC11

锁紧方式 | Clamping
螺钉式 Screw

接口规格 | Coupling type
芯轴 Arbor

精镗刀 BFC



直径范围 | Processing range
1mm-54mm

刀片类型 | Insert type
TC11

锁紧方式 | Clamping
螺钉式 Screw

接口规格 | Coupling type
CK

精镗刀 BFG



直径范围 | Processing range
200mm-550mm

刀片类型 | Insert type
TC11

锁紧方式 | Clamping
螺钉式 Screw

接口规格 | Coupling type
CK、PSC

PSC 产品

PSC PRODUCT



产品优势 PRODUCT ADVANTAGES

- 重复定位精度达到 0.002mm, 可实现高效换刀
- 相对传统车刀, 无需机内对刀, 减少停机等待时间
- 180°旋转接纳器端盖即可实现左右手互换使用, 减少刀具库存成本
- PSC 接口为 1:20 三棱短锥, 双向定位, 刚性好, 传扭能力强
- The repeated positioning accuracy can reach 0.002mm
- Compared with the traditional turning tools, no need to adjust the tool in the machine and reduce the downtime
- Through the 180° rotation receiver, the left and right turning tools can be interchanged, to reduce the inventory cost of tools and fixtures
- PSC interface is a 1:20 polygon short taper holder with bidirectional positioning, good rigidity and strong torque transmission ability

SOFTCOOL



应用行业 APPLICATIONS

- 应用于航空航天、汽车制造、模具、医疗器械、能源装备制造、工业零件等领域
- Can be widely used in the fields of aerospace, automobile manufacturing, mold and die, medical equipment, industrial components and so on



PSC 接口
PSC Coupling

外圆车刀体 EXTERNAL TURNING TOOL BODY



内圆车刀体 INTERNAL TURNING TOOL BODY

接口规格 | Coupling type PSC32-PSC100

锁紧方式 | Clamping 螺钉式 Screw、勾杆式 Hook
压板式 Platen

刀片类型 | Insert Type TN19、CC12、VB16、VN16
CN12-CN19、DC07-DC11
DN11-DN15、RC10-RC16
SN12-SN19、WN06-WN08

PSC 接纳器 PSC CLAMPING UNIT

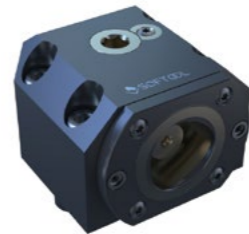

接口规格 | Coupling type
PSC32-PSC100

刀体方向 | Direction of tool
左手方向 Left、右手方向 Right
不区分左右手方向 Null

产品种类 | Product type
通用接纳器 General purpose receiver
VDI 接纳器
VDI Receiver

卧式刀塔接纳器 Horizontal lathe receiver
液压驱动接纳器 Hydraulic actuated receiver

转接柄 ADAPTOR



接口规格 | Coupling type
PSC32-PSC100

转换接口规格 | Interface
PSC-Arbor
PSC-BT
PSC-HSK
PSC-PSC

有效长度 | Length
25mm-200mm

卡具 CHUCKS



产品优势 PRODUCT ADVANTAGES

- 高精度 径向跳动精度 < 0.01mm
- 高刚性 短夹持 最短夹持可达 3mm
- 高夹持力 全包围式平行夹紧自定心带后拉
- 大径向行程 ±0.5mm 适用自动化
- High accuracy run-out accuracy < 0.01mm
- High rigidity Short clamping length The clamping of extremely smallest length (starts at 3mm)
- High holding power Full enclosed, parallel clamping, self-centering with pull-back
- Large radial clamping/release stroke ±0.5mm is suitable for automation



应用行业 APPLICATIONS

- 应用于航空航天、汽车制造、齿轮传动、工程塑料等领域
- Can be widely used in the fields of aerospace, Transmission gear, Automotive, Plastic industry and so on

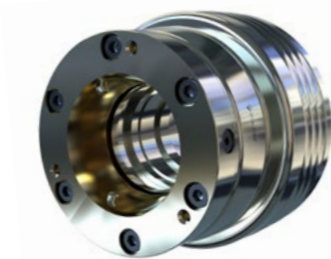

卡盘
CHUCK

夹持范围 | Clamping range
4-160mm

径向跳动精度 | Run-out
0.01

行程 | Stroke
±0.05mm

最大径向夹持力 kN
Max.radial clamping force
105

最大轴向拉杆拉力 kN
Max.axial drawtube force (pull/push)
45



芯轴
MANDREL

夹持范围 | Clamping range
8-200mm

径向跳动精度 | Run-out
0.01

行程 | Stroke
±0.35mm

最大径向夹持力 kN
Max.radial clamping force
105

最大轴向拉杆拉力 kN
Max.axial drawtube force (pull/push)
25

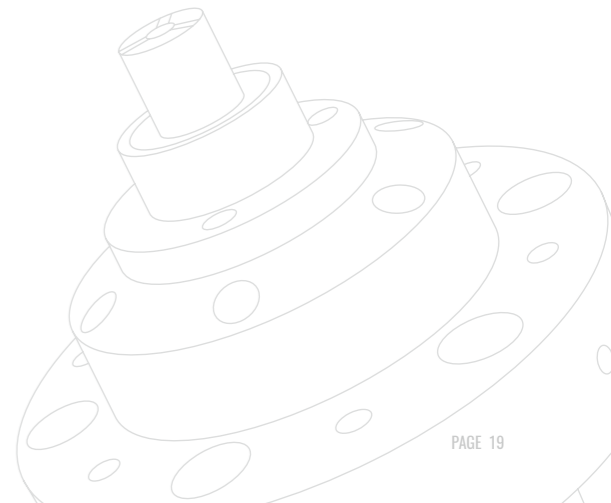
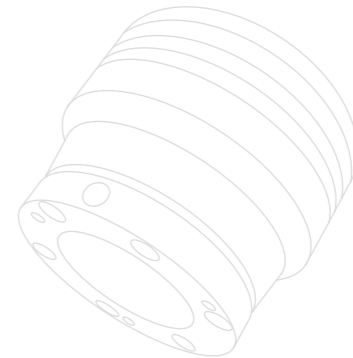

曲轴刀具

CRANKSHAFT
CUTTER



百斯图曲轴刀具集技术、经验、能力于一身，拥有超过 300 份以上的曲轴加工案例。

SofTool crankshaft milling tool integrates technology, experience and capacity. We have more than 300 successful crankshaft processing cases.



专业的研发、生产、制造是百斯图曲轴刀具在行业立足的根本，可提供刀盘、刀夹、刀片、配件及周边产品的全套加工解决方案。

With the ability of professional design and development, manufacturing and technical support, we can provide a full range of machining solutions for milling cutters, cartridges, inserts, accessories and associated products.



着眼未来，百斯图用专业与您携手共进，合作共赢。

Focusing on the future, SofTool will work with you hand in hand with professionalism to achieve win-win cooperation.



外铣

EXTERNAL MILLING

轮廓直径可达 Dc1000mm，端跳、径跳可控致在 0.025mm 以内

Maximum contour diameter Dc1000mm, axial and radial runout within 0.025mm

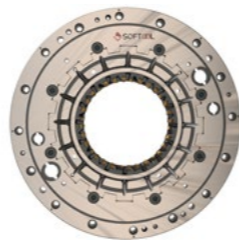

内铣

INTERNAL MILLING

外径可达 Dc1000mm，可提供整体式与模块式刀盘

Maximum contour diameter Dc1000mm, provide integrated and modular cutter

端跳、径跳可控致在 0.025mm 以内

Maximum contour diameter Dc1000mm, axial and radial runout within 0.025mm



车-车拉

TURN-TURN BROACHING

轮廓直径可达 Dc1000mm，根据需求可定制 12-45 工位刀夹

Maximum contour diameter Dc1000mm, according to the demand, 12-45 stations cutter tool can be customized

套车

SLEEVE TURNING TOOL

根据图纸要求，可提供 7:24、HSK 等接口的复合套车刀

According to the drawings, composite sleeve turning tool coupling with 7:24, HSK, etc. can be provided



型线刀具

PROFILE CUTTER



可转位刀片滚刀
INDEXABLE HOB CUTTER

模数 | Modulus
≥ 6

精度等级 | Accuracy class
可达 A 级 Up to level A



钢轨修复铣刀
RAIL REPAIR MILLING CUTTER

轮廓直径可达 Dc1000mm, 端跳、
径跳可控致在 0.03mm 以内

Maximum contour diameter Dc1000mm,
axial and radial runout within 0.03mm



刮齿刀
INSERT SKIVING CUTTER

模数 | Modulus
3-7

精度等级 | Accuracy class
可达 7 级 Up to level 7



螺杆压缩机转子铣刀
SCREW COMPRESSOR ROTOR
MILLING CUTTER

螺杆铣刀应用于压缩机阴阳转子的粗加工及精加工
Screw milling cutter is used in roughing and finishing
of compressor female and male rotor

刀具直径 | Tool diameter
200-600mm



齿轮铣刀
GEAR MILLING CUTTER

模数 | Modulus
6-40

精度等级 | Accuracy class
可达 7 级 Up to level 7



齿轮粗铣刀
GEAR ROUGH MILLING CUTTER

模数 | Modulus
20

精度等级 | Accuracy class
可达 8 级 Up to level 8



齿轮精铣刀
GEAR FINISHING CUTTER

模数 | Modulus
6-40

精度等级 | Accuracy class
可达 7 级 Up to level 7



插齿刀
INSERT SLOTTING CUTTER

模数 | Modulus
3-10

精度等级 | Accuracy class
可达 7 级 Up to level 7



罗茨真空泵转子铣刀
ROOTS VACUUM PUMP ROTOR
MILLING CUTTER

罗茨真空泵转子铣刀应用于“8”形转子的粗加工及精加工

Roots vacuum pump rotor milling cutter is used in
roughing and finishing of “8” shape rotor



微信公众号

联系方式 | CONTACT INFORMATION

📍 OEM/海外 OEM/Oversea sales

👤 程经理 Barry Cheng

☎ +86 131 1000 1570

📍 标准产品 Standard Product

👤 管经理 Gordon Guan

☎ +86 186 2267 5164

📍 行业定制 Industrial Customization

👤 陈经理 Bob Chen

☎ +86 189 3144 7020

TEL: 022-60379917 E-mail: softool.sale@cxtc.com

ADD: 天津市武清区京滨工业园京滨大道99号 No. 99, Jingbin Avenue, Jingbin Industrial Park, Wuqing District, Tianjin, China